



ASPIRATORI INDUSTRIALI AD ALTE PRESTAZIONI

PERCHÉ UTILIZZARE UN ASPIRATORE?



L'aspirazione industriale è un elemento chiave per garantire la pulizia e l'efficienza degli ambienti di lavoro. Polvere, solidi, liquidi e rifiuti sono infatti un problema comune nell'industria, soprattutto in settori come la lavorazione del legno, la produzione di cemento e ceramica, la metallurgia e l'ingegneria meccanica. La gestione di questi materiali di scarto è fondamentale per garantire un ambiente di lavoro sicuro e pulito e per mantenere elevati standard di efficienza e produttività.



PULIZIA EFFICACE E VELOCE

dell'area di lavoro e degli spazi circostanti



SICUREZZA

per i lavoratori e l'ambiente di lavoro



PRODUTTIVITÀ

ridurre gli incidenti e i tempi di fermo

SICUREZZA PER I LAVORATORI E PER L'AMBIENTE



ROBUSTA STRUTTURA IN METALLO

Per garantire durata e affidabilità anche in caso di lavori pesanti.



PRESTAZIONI ELEVATE

Ampia scelta di aspiratori per le più diverse applicazioni.



POSSIBILITÀ DI PERSONALIZZAZIONE

Ampia possibilità di personalizzazione, per soddisfare requisiti specifici.

Con il giusto aspiratore per polveri fini o pericolose, è possibile lavorare in totale sicurezza. Gli aspiratori Depureco sono dotati di filtri di classe M, adatti a una protezione quotidiana. Per i lavori più impegnativi e per il massimo livello di sicurezza, è possibile scegliere filtri di classe H, capaci di catturare particelle ancora più sottili e garantendo la massima protezione.

COME FUZIONA?

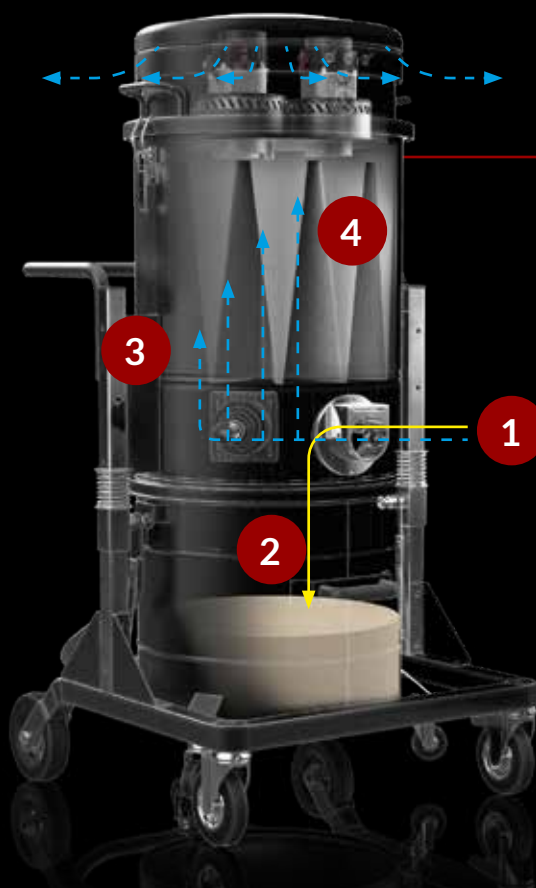

1. La polvere viene aspirata dal bocchettone di aspirazione.
2. Le particelle di polvere cadono verso il basso, all'interno del contenitore.
3. L'aria sale verso il filtro di aspirazione ed esce dalla testa della macchina.
4. Le particelle più leggere si bloccano sulla superficie del filtro proteggendo i motori.

● Polvere ● Aria

QUALCHE ESEMPIO DI APPLICAZIONE



Aspirazione liquidi



Aspirazione di polveri sottili



Raccolta trucioli metallici da macchine CNC



Pulizie in altezza



Aspirazione di materiali caldi



Pulizia dei pavimenti

COME SCEGLIERE?



UNITÀ DI ASPIRAZIONE



MOTORI MONOFASE

Concepiti per un uso non continuativo della macchina, garantiscono elevate prestazioni. Ogni motore è gestito da un interruttore indipendente, che consente all'operatore di controllare le performance dell'aspiratore.

- Potente e altamente affidabile
- Lunga durata, fino a 1.300 ore



TURBINA A CANALE LATERALE

Turbina a canale laterale con accoppiamento diretto tra albero motore e girante. Essendo priva di sistemi di trasmissione, la turbina non richiede alcuna manutenzione ordinaria, ed è adatta per lavorare in modo continuativo. Con valvola di sicurezza.

- Per lavori continui 24/7
- Non necessita di manutenzione ordinaria



BATTERIA

Con le nostre batterie da 24 Volt è possibile usufruire di un elevato livello di aspirazione anche in contesti dove non sono disponibili fonti di energia elettrica.

- Mobilità senza compromessi
- Non è necessaria una presa di corrente vicina

OPZIONI DI FILTRAZIONE



M

Filtro in poliestere per polveri di categoria M.

Efficienza di filtrazione fino a 1 μ .

Disponibile anche in versione antistatica.



MTF

Filtro in poliestere con rivestimento in teflon, particolarmente adatto per materiali molto appiccicosi.



NOMEX

Filtro resistente alle alte temperature, ideale per l'aspirazione di polveri calde.



PTFE

Filtro in poliestere misto teflon, particolarmente adatto per aspirare polveri sottili e materiali appiccicosi.

Disponibile anche in versione antistatica.



HEPA 13

Filtro assoluto a cartuccia per polveri molto fini. Alta efficienza di filtrazione.

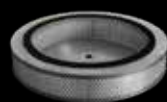

HEPA 14

Filtro a cartuccia ad alta efficienza per polveri sottili. Aspira il 99.995% delle particelle fino a 0.18 μ .

SISTEMI DI PULIZIA DEL FILTRO

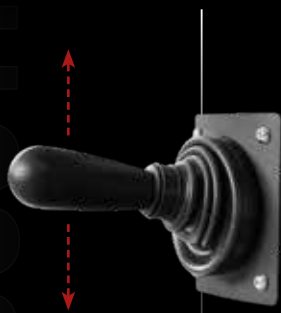

MANUALE

L'aspiratore è dotato di una leva collegata direttamente al filtro. Il movimento verticale della leva comprime il filtro, facendo sì che il materiale si stacchi dalla sua superficie e cada nel contenitore.

Disponibile con scuotimento pneumatico (PSC).



SP

Ogni cartuccia viene pulita a intervalli regolabili da un getto d'aria ad alta pressione (6 bar), che scuote la cartuccia, rimuovendo grandi quantità di materiale dal filtro e rendendolo completamente pulito in pochi secondi. Necessita di aria compressa.

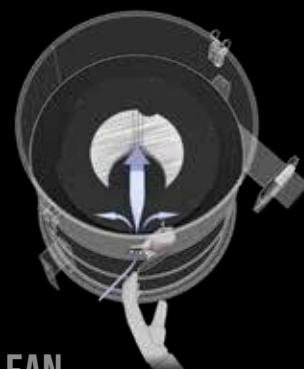

JET-CLEAN

Il sistema JetClean® sfrutta il differenziale di pressione tra l'interno e l'esterno dell'aspirapolvere per eseguire una pulizia rapida ed efficace, senza dover spegnere la macchina. Abbinato alla ghigliottina SD.

SISTEMI DI RACCOLTA



CONTENITORE

Facile da sganciare e realizzato in acciaio (disponibile INOX), il contenitore consente una facile gestione del materiale raccolto.



ENDLESS BAG

Il sistema di raccolta a rotolo continuo "Endless Bag" offre una soluzione sicura per la raccolta e lo smaltimento di polveri sottili e tossiche, perché evita il contatto dell'operatore con materiali pericolosi.

OVERVIEW



	XM 20	XM 20 JETCLEAN	XM 35 JETCLEAN	MINIBULL
ALIMENTAZIONE	 230 V	 230 V	 230 V	 230 V
MOTORI	 Due motori	 Due motori	 Due motori	 Due motori
UTILIZZO	Utilizzo non continuo Polveri	Utilizzo non continuo Polveri	Utilizzo non continuo Polveri+Liquidi	Utilizzo non continuo Polveri+Liquidi
PULIZIA DEL FILTRO	Manuale	JetClean semi automatica	JetClean semi automatica	Manuale
SISTEMA DI RACCOLTA	Contenitore 20 Lt	Contenitore 20 Lt	Contenitore 45 Lt o Endless bag	Contenitore 45 Lt
CERTIFICAZIONE ATEX DISPONIBILE	-	-	-	-



	M 65/100	M 65/100 JETCLEAN TAN	BULL 24	FOX 24
ALIMENTAZIONE	 230 V	 230 V	 Batteria 24 V	 Batteria 24 V
MOTORI	 Tre motori	 Tre motori	 Tre motori	 Tre motori
UTILIZZO	Utilizzo non continuo Polveri+Liquidi	Utilizzo non continuo Polveri+Liquidi	Utilizzo non continuo Polveri+Liquidi	Utilizzo non continuo Polveri+Liquidi
PULIZIA DEL FILTRO	Manuale	JetClean semi automatica	Manuale	Manuale
SISTEMA DI RACCOLTA	Contenitore 65/100 Lt o Endless bag	Contenitore 65/100 Lt o Endless bag	Contenitore 65/100 Lt	Contenitore 65/100 Lt
CERTIFICAZIONE ATEX DISPONIBILE	-	-	-	-



	WD	WD PUMP	TB	TB UP
ALIMENTAZIONE	230 V	230 V	230/400 V	400 V
MOTORI	Due o tre motori	Due motori	Turbina a canale laterale	Turbina a canale laterale
UTILIZZO	Utilizzo non continuo Liquidi	Utilizzo non continuo Liquidi + aspirazione e scarico in simultanea	Utilizzo continuo Polveri+Liquidi	Utilizzo continuo Polveri+Liquidi
PULIZIA DEL FILTRO	-	-	Manuale	Manuale
SISTEMA DI RACCOLTA	Contenitore 130 Lt	Contenitore 130 Lt	Contenitore 45 Lt	Contenitore 45 Lt
DISPONIBILE CON CERTIFICAZIONE ATEX	-	-	✓	✓



	ECOBULL	TX	FOX	PUMA
ALIMENTAZIONE	230/400 V	400 V	400 V	400 V
MOTORI	Turbina a canale laterale	Turbina a canale laterale	Turbina a canale laterale	Turbina a canale laterale
UTILIZZO	Utilizzo continuo Polveri+Liquidi	Utilizzo continuo Polveri+Liquidi	Utilizzo continuo Polveri+Liquidi	Utilizzo continuo Polveri
PULIZIA DEL FILTRO	Manuale	Manuale	Manuale	Manuale o scuotifiltro elettrico "SE"
SISTEMA DI RACCOLTA	Contenitore 65/100 Lt o Endless bag	Contenitore 100 Lt o Endless bag	Contenitore 100 Lt o Endless bag	Contenitore 175 Lt
CERTIFICAZIONE ATEX DISPONIBILE	✓	✓	✓	✓

XM 20



Codici: **A1400-001**



2 motori By-Pass



Filtro classe M



Scuotifiltro manuale



Kit filtro HEPA (H14)



Ingresso 50 mm con deflettore



Contenitore da 20 Lt



Potenza: 2,6 kW



Capacità: 20 Lt



Superficie filtrante: 15000 cm²



Dimensioni: mm 516 X 545 X 994 h

XM 20 JETCLEAN



Codice: **A1400**



2 motori By-Pass



Sistema di pulizia del filtro JetClean®



Cartuccia conica classe M



Kit filtro HEPA (H14)



Ingresso 50 mm con ghigliottina



Contenitore 20 Lt



Potenza: 2,6 kW



Capacità: 20 Lt



Superficie filtrante: 35.000 cm²



Dimensioni: mm 516 X 545 X 994 h

XM 35 JETCLEAN

Codice: **A1420**



2 motori By-Pass



Sistema di pulizia del filtro JetClean®



Cartuccia conica classe M



Kit filtro HEPA H14



Ingresso 50 mm con ghigliottina



Contenitore 45 Lt

Endless bag disponibile



Potenza: 2,6 kW



Capacità: 45 Lt



Superficie filtrante: 35.000 cm²



Dimensioni: mm 585 X 545 X 1285 h

MINIBULL

Codice: **A715**



2 motori By-Pass



Filtro classe M



Scuotifiltro manuale

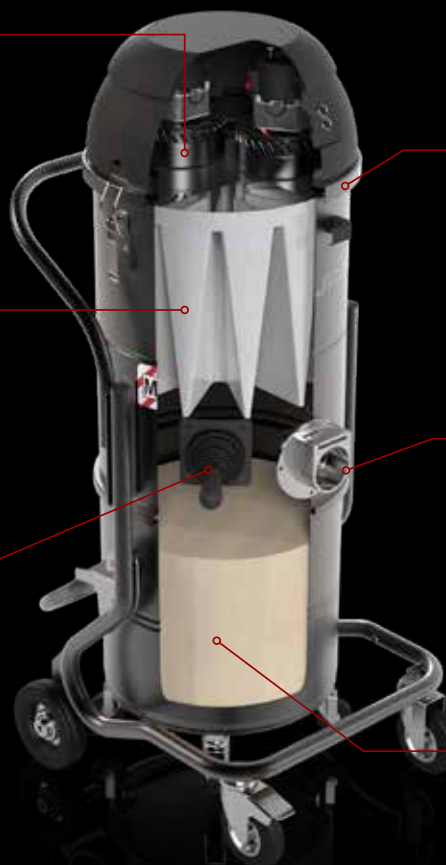

Kit filtro HEPA (H14)



Ingresso 70 mm con deflettore



Contenitore 45 Lt



Potenza: 2,6 kW



Capacità: 45 Lt



Superficie filtrante: 15.000 cm²



Dimensioni: mm 550 X 620 X 1240 h

M65/100

Codice: **A032/A039**



- Potenza: 3,9 kW
- Capacità: 65/100 Lt
- Superficie filtrante: 24.000 cm²
- Dimensioni: mm 660 X 800 X 1300/1515 h



M65/100 JetClean® TAN

Codici: **A1550/A1560**



- Potenza: 3,9 kW
- Capacità: 65/100 Lt
- Superficie filtrante: 35.000 cm²
- Dimensioni: mm 660 X 800 X 1300/1515 h



BULL 24

Codice: **A368**



3 motori By-Pass



Filtro classe M



Batterie 24 volt

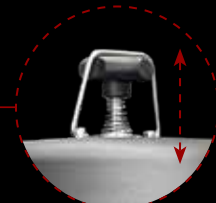

Scuotifiltro manuale



Ingresso tangenziale 80 mm con ciclone



Contentore 65/100 Lt



Potenza: 1,5 kW



Capacità: 65/100 Lt



Superficie filtrante: 24.000 cm²



Dimensioni: mm 650 X 850 X 1400 h

FOX 24

Codice: **A410**



3 motori By-Pass



Filtro classe M



Batterie 24 Volt

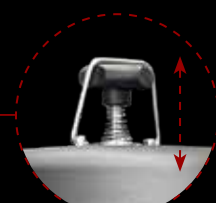

Scuotifiltro manuale



Ingresso tangenziale 80 mm con ciclone



Contentore 65/100 Lt



Potenza: 1,5 kW



Capacità: 65/100 Lt



Superficie filtrante: 24.000 cm²



Dimensioni: mm 650 X 1200 X 1400h

WD 132/133

Codici: A1571/A1572

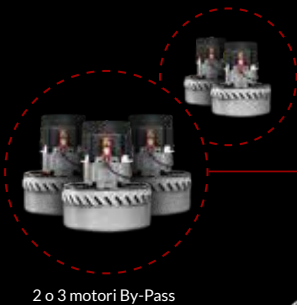

2 o 3 motori By-Pass

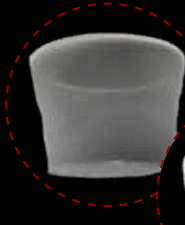

Filtro solidi



Filtro liquidi

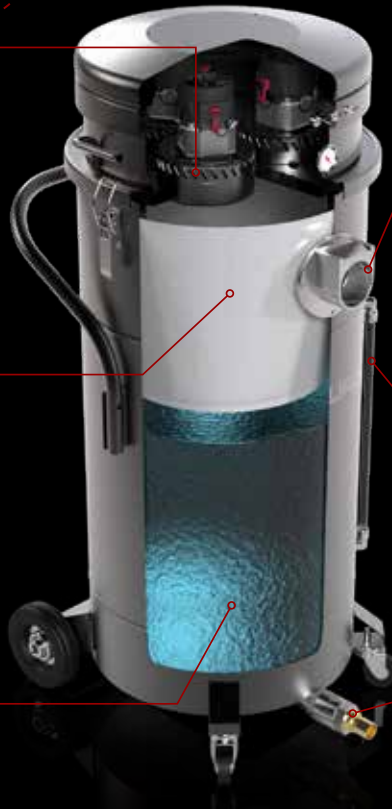

Ingresso 70 mm con deflettore



Indicatore di livello



Rubinetto di scarico



Potenza: da 2,6 to 3,9 kW



Capacità: 130 Lt



Dimensioni: mm 580 X 530 X 1160 h

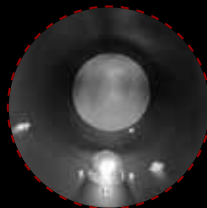

Capacità 130 Lt

WD 132 P

Codice: A1570



2 motori By-Pass

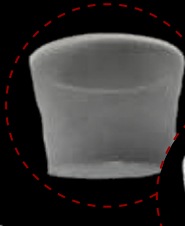

Filtro solidi



Filtro liquidi



Ingresso 70 mm con deflettore



Indicatore di livello



Rubinetto di scarico



Potenza: 2,6 kW



Capacità: 130 Lt



Dimensioni: mm 580 X 530 X 1160 h



Pompa di scarico interna



Capacità 130 Lt

TB 18/22

Codici: **A923/A940**



Turbina a canale laterale



Filtro classe M



Scuotifiltro manuale

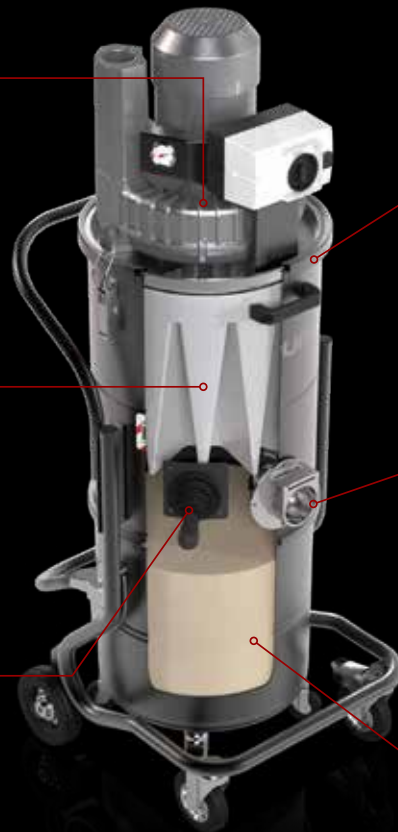

Kit filtro HEPA (H14)



Ingresso 70 mm con deflettore



Contenitore 45 Lt



Potenza: 1,8/2,2 kW



Capacità: 45 Lt



Superficie filtrante: 15.000 cm²



Dimensioni: mm 550 X 620 X 1353 h

TB UP 3/4

Codici: **A878/A875**



Filtro classe M



Turbina a canale laterale



Scuotifiltro manuale

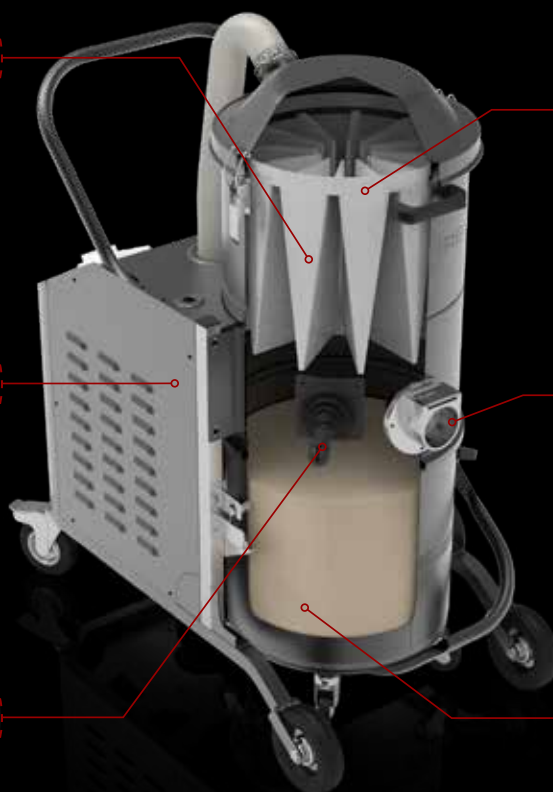

Kit filtro HEPA (H14)



Ingresso 70 mm con deflettore



Contenitore 45 Lt



Potenza: 3/4 kW



Capacità: 45 Lt



Superficie filtrante: 15.000 cm²



Dimensioni: mm 550 X 900 X 1120 h

ECOBULL

Codici: **A1004/A980/A1006**



Turbina a canale laterale



Kit filtro HEPA (H14)



Filtro classe M



Ingresso 70 mm con deflettore



Potenza: da 1,8 to 4 kW



Capacità: 65/100 Lt



Superficie filtrante: 24.000 cm²



Dimensioni: mm 660 X 800 X 1530 h



Scuotifiltro manuale



Contenitore 65/100 Lt

Endless bag disponibile

TX

Codici: **A1500/A1486/A1487/A1488/A1489/A1490**



Filtro classe M

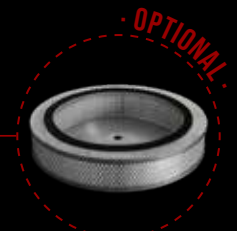

Kit filtro HEPA (H14)



Turbina a canale laterale



Ingresso 70 mm con deflettore



Potenza: da 3 a 7,5 kW



Capacità: 100 Lt



Superficie filtrante: 38.000 cm²



Dimensioni: mm 650 X 1100 X 1400 h



Scuotifiltro manuale



Contenitore 100 LT

Endless bag disponibile

FOX

Codici: **A134/A159/A170/A197**



Filtro classe M

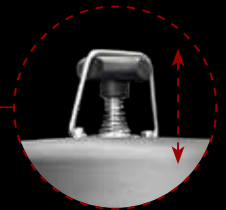

Scuotifiltro manuale



Turbina a canale laterale



Kit filtro HEPA (H14)



Contenitore 100 Lt



Endless bag disponibile



Ingresso tangenziale 80 mm con ciclone



Potenza: from 4 to 5,5 kW



Capacità: 100 Lt



Superficie filtrante: 24.000 cm²



Dimensioni: mm 660 X 1200 X 1510 h

PUMA

Codici: **A500/A540/A560/A580/A571/A557/A574**



Kit filtro HEPA (H14)



Scuotifiltro manuale



Turbina a canale laterale



Ingresso tangenziale 80 mm con ciclone



Contenitore 175 Lt



Filtro classe M



Potenza: da 7,5 a 18,5 kW



Capacità: 175 Lt



Superficie filtrante: 45.000 cm²



Dimensioni: mm 850 X 1550 X 1980 h

PUMA

Codici: **A600/A610/A619/A624**



Kit filtro HEPA (H14)



Turbina a canale laterale



Contenitore 175 Lt



"SE" Scuotifiltro elettrico



Ingresso tangenziale 80 mm con ciclone



Filtro classe M



Potenza: da 22 a 25 kW



Capacità: 175 Lt



Superficie filtrante: 110.000 cm²



Dimensioni: mm 1050 X 1950 X 2300 h

PRE-SEPARATORI

Per sfruttare appieno le potenzialità del vostro aspiratore, scegliete di utilizzare un pre-separatore! I pre-separatori, infatti, non solo aumentano la capacità di raccolta, ma salvaguardano anche il filtro dell'aspiratore, prolungandone la durata. Aspiratore e pre-separatore sono una coppia invincibile e riescono a gestire senza sforzo tanti diversi materiali.

+

CAPACITA'

+

RESISTENZA



IMPIANTI CENTRALIZZATI

+ MOLTEPLICI PUNTI DI ASPIRAZIONE

+ EFFICIENZA



Rivoluziona le operazioni di pulizia industriale con i sistemi di aspirazione centralizzati! Questi impianti hanno una potenza di aspirazione superiore, sono poco rumorosi e permettono di aspirare simultaneamente in più punti con un'unica unità aspirante. Si rende così più semplice la manutenzione dei locali di lavoro e dei macchinari e la qualità dell'aria migliora nettamente, insieme all'efficienza e alla produttività.



ASPIRATORI ACD E CERTIFICATI ATEX

ATEX

Depureco produce aspiratori con certificazioni di categoria **3D | 3GD - 1/2D | 1/3D** specificamente progettati per l'uso in zone a rischio **ROSSO**.

*	HIGH RISK	MED RISK	LOW RISK
DUST	ZONE 20	ZONE 21	ZONE 22
GAS	ZONE 0	ZONE 1	ZONE 2

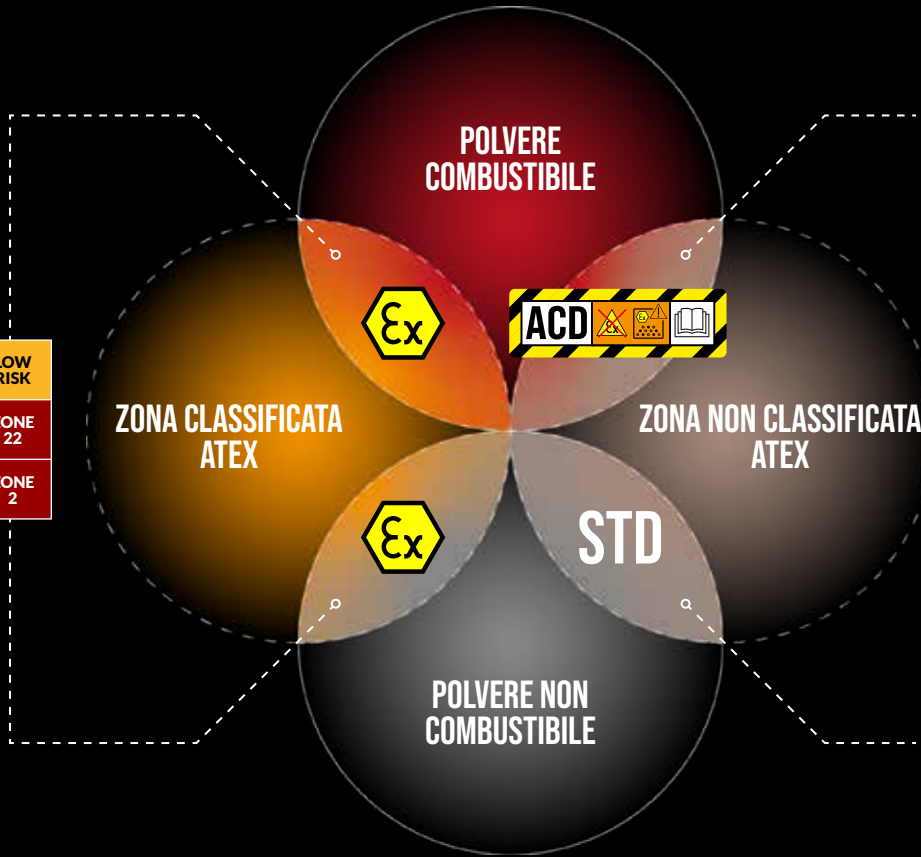

ACD

Gli aspiratori industriali ACD sono progettati per aspirare polveri combustibili in zone non classificate ATEX.

STANDARD

Aspiratori industriali per applicazioni ordinarie.

PROGETTATI PER LA SICUREZZA



TURBINE CERTIFICATE ATEX

TUTTI I COMPONENTI SONO MESSI A TERRA

CONTENITRE IN ACCIAIO INOX AISI 304

ACCESSORI E FILTRO ANTISTATICI

PRINCIPALI OPTIONAL

FILTRAZIONE H14



P12279

22.000 Filtro HEPA H14

P09868

28.000 Filtro HEPA H14

P11640

22.000 H14 Filtro HEPA

P11363

110.000 Filtro HEPA H14

KIT RIBALTAMENTO CONTENITORE

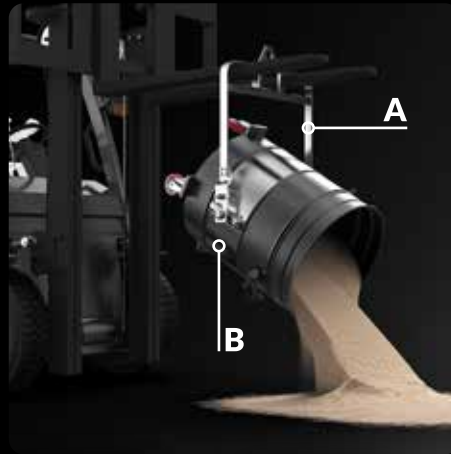

P01033

100 Lt | Staffa di sollevamento "A"

P01034

175 Lt | Staffa di sollevamento "A"

P11287

100 Lt | Anello per assicurare il contenitore "B"

P00273

175 Lt | Anello per assicurare contenitore "B"

ACCESSORIO FISSO PER PULIZIA PAVIMENTI



P00327

Accessorio fisso per la pulizia dei pavimenti Ø40

P11792

Accessorio fisso per la pulizia dei pavimenti Ø70

SISTEMA DI RACCOLTA A SACCO



P09252

Fermasacco per sacchetto monouso

ASPIRAZIONE LOCALIZZATA



P14025

Braccio aspirante snodabile Ø70

ASPIRAZIONE LIQUIDI



P12005

Galleggiante 45 Lt

P12004

Galleggiante 65 Lt

ACCESSORI

KIT



P13638
Starter kit Ø40



P13639
Wet & Dry kit Ø40



P11887
Wet & Dry kit Ø50



P12350
Starter kit Ø50



P13640
Dry kit Ø40



P12348
Dry kit Ø50



P14048/5
Dry kit Ø70



P14052
Kit pulizie in altezza
Ø40



P14050/5
Heavy duty starter
kit Ø70



P14049/5
Heavy duty kit PRO
Ø70

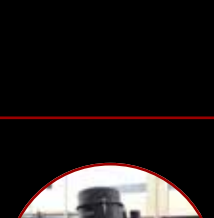

P14053
Kit pulizie in altezza
Ø50

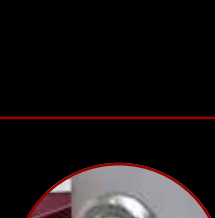

P14051/5
Bulk kit Ø70

P11857
Kit pulizia forni Ø40

OPZIONI



BX - GX - TX

BX - contenitore in acciaio inox.
GX - Contenitore e camera in acciaio Innox.
TX - Contenitore, camera e struttura in acciaio inox.



FKL

Per sollevare e spostare l'aspiratore con il muletto.



GFR

Golfari posizionati sulla struttura dell'aspiratore per facilitarne il sollevamento.



AB

Cestello portaccessori.



GRD

Tutti i componenti conduttivi dell'aspirapolvere sono messi a terra per scaricare le cariche elettrostatiche.



PRV

Valvola di sicurezza che impedisce la sovrappressione e il surriscaldamento dell'aspiratore.



TAN

Ingresso tangenziale. Il ciclone interno rallenta il materiale aspirato e lo fa cadere nel contenitore grazie all'effetto ciclonico.



KDP

Kit per mantenere correttamente posizionato il sacchetto usa e getta.



RC

Presca Schuko 24 VAC per l'alimentazione e il controllo a distanza degli utensili elettrici.



LR

Predisposizione al collegamento con il telecomando.



WRLS

Accensione e spegnimento tramite telecomando wireless.



SPARK TRAP

Sistema che impedisce alle scintille, anche ardenti, di raggiungere l'interno dell'aspiratore.

SCOPRI LE ALTRE PROPOSTE DEPURECO



ASPIRATORI INDUSTRIALI PER OLIO E TRUCIOLI

Aspiratori industriali progettati per facilitare e velocizzare la manutenzione dei macchinari CNC.



ASPIRATORI INDUSTRIALI AD ARIA COMPRESSA

Aspiratori industriali che possono essere utilizzati con l'ausilio dell'aria compressa in ambienti dove non c'è la possibilità di utilizzare l'elettricità.



DEPOLVERATORI

Aspiratori industriali per il recupero di polveri volatili o in sospensione.



ASPIRATORI PER SFRIDI, CONFEZIONAMENTO & OEM

Aspiratori industriali dedicati all'uso e all'integrazione a bordo macchina.



ASPIRATORI INDUSTRIALI PER TRATTAMENTO SUPERFICI

Aspiratori industriali dedicati alla pulizia di polveri fini e pericolose durante i processi di trattamento delle superfici.



ASPIRATORI INDUSTRIALI ATEX

Aspiratori industriali certificati per l'utilizzo in zone ATEX.



ASPIRATORI INDUSTRIALI PER FUMI DI SALDATURA

Progettati per aspirare in modo localizzato e sicuro i fumi di saldatura.



IMPIANTI CENTRALIZZATI

Sistemi di aspirazione centralizzati per la pulizia di grandi ambienti di lavoro con punti di aspirazione multipli e integrazione nel processo produttivo.



ASPIRATORI INDUSTRIALI PER POLVERI COMBUSTIBILI

Soluzioni di aspirazione industriale per la raccolta o l'inertizzazione sicura di polveri combustibili in zone NON certificate ATEX.

MONOFASE



		XM 20	XM 20 JC	XM 35 JC	MINIBULL	M65/100	M65/100 JC TAN	BULL 24	FOX 24	WD 132	WD 132 P	WD 133
Codice		A1400-001	A1400	A1420	A715	A032/A039	A1550/A1560	A368	A410	A1571	A1570	A1572
Codice con Endless bag		-	-	A1421	-	A1565	A1551	-	-	-	-	-
Potenza	kW-HP	2,6 - 3,5	2,6 - 3,5	2,6 - 3,5	2,6 - 3,5	3,9 - 5,2	3,9 - 5,2	1,5 - 2	1,5 - 2	2,6 - 3,5	2,6 - 3,5	3,9 - 5,2
Voltaggio / Frequenza	V Hz	230 50/60	230 50/60	230 50/60	230 50/60	230 50/60	230 50/60	24	24	230 50/60	230 50/60	230 50/60
IP		-	-	-	-	-	-	-	-	-	-	-
Massimo vuoto	mBar	250	250	250	250	250	250	240	240	250	250	250
Massima portata d'aria	m³/h	380	380	380	380	570	570	350	350	380	380	570
Bocca aspirante	Ømm	50	50	50	50	70/centrale	70/tangenziale	80/tangenziale	80/tangenziale	70	70	70
Livello di rumorosità	dB(A)	72	72	72	72	72	72	64	64	72	72	72
Capacità del contenitore	Lt	20	20	45	45	65/100	65/100	65/100	65/100	130	130	130
Dimensioni	mm	516 X 545	516 X 545	585 X 545	550 X 620	660 X 800	660 X 800	650 X 850	660 X 1200	580 X 530	580 X 530	580 X 530
Altezza	mm	994	994	1.285	1.240	1.300/1.515	1.300/1.515	1.400	1.400	1.160	1.160	1.160
Peso	Kg	38	38	45	45	80	80	75	100	38	47	40

Filtro primario

Superficie	cm²	15000	35000	35000	15000	24000	35000	24000	24000	-	-	-
Classe EN 60335-2-69	IFA BGIAM-PES	Classe M	Classe M	Classe M	Classe M	Classe M	Classe M	Classe M	Classe M	-	-	-
Materiale		Poliestere	PTFE Poliestere rivestito	PTFE Poliestere rivestito	Poliestere	Poliestere	PTFE Poliestere rivestito	Poliestere	Poliestere	PPL nylon polipropilene	PPL nylon polipropilene	PPL nylon polipropilene
Sistema di pulizia del filtro		Manuale	JetClean	JetClean	Manuale	Manuale	JetClean	Manuale	Manuale	-	-	-

TRIFASE

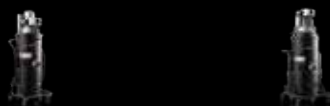

		TB 18 M	TB 22	ECOBULL M	ECOBULL T	ECOBULL PLUS
Codice		A923	A940	A1004	A980	A1006
Potenza	kW-HP	1,8 - 2,4	2,2 - 3	1,8 - 2,4	3 - 4	4 - 5,5
Voltaggio / Frequenza	V Hz	230 50/60	230 50/60	230 50/60	230 50/60	230 50/60
IP		55 F	55 F	55 F	55 F	55 F
Vuoto in continuo	mBar	230	220	230	230	270
Massima portata d'aria	m³/h	240	280	240	340	340
Bocca di aspirazione	Ømm	70	70	70	70	70
Livello di rumorosità	dB(A)	74	74	74	72	72
Capacità del contenitore	Lt	45	45	65/100	65/100	65/100
Dimensioni	mm	550 X 620	550 X 620	660 X 800	660 X 800	660 X 800
Altezza	mm	1.353	1.353	1.530	1.530	1.530
Peso	Kg	50	55	85	88	95

Filtro primario

Superficie	cm²	15.000	15.000	24.000	24.000	24.000
Classe EN 60335-2-69	IFA BGIAM-PES	Classe M	Classe M	M Class	M Class	M Class
Materiale		Poliestere	Poliestere	Poliestere	Poliestere	Poliestere
Sistema di pulizia del filtro		Manuale	Manuale	Manuale	Manuale	Manuale

TRIFASE



		TB UP 3	TB UP 4	TX 300	TX 400 P	TX 400 S	TX 550 P	TX 550 S	TX 750	FOX 5,5 P	FOX 5,5 S	FOX 7,5 P	FOX 7,5 P
Codice		A878	A875	A1500	A1486	A1487	A1488	A1489	A1490	A134	A159	A170	A197
Codice con Endless bag		-	-	A1505	A1479	A1474	A1519	A1514	A1466	A138	A145	A186	A195
Potenza	kW-HP	3 - 4	4 - 5,5	3 - 4	4 - 5,5	4 - 5,5	5,5 - 7,5	5,5 - 7,5	7,5 - 10	4 - 5,5	4 - 5,5	5,5 - 7,5	5,5 - 7,5
Voltaggio / Frequenza	V/Hz	400 50/60	400 50/60	400 50/60	400 50/60	400 50/60	400 50/60	400 50/60	400 50/60	400 50/60	400 50/60	400 50/60	400 50/60
IP		55 F	55 F	55 F	55 F	55 F	55 F	55 F	55 F	55 F	55 F	55 F	55 F
Vuoto in continuo	mBar	230	270	230	160	360	260	440	260	160	360	240	440
Massima portata d'aria	m³/h	340	340	350	530	330	530	330	730	520	320	520	320
Bocca di aspirazione	Ømm	70	70	70	70	70	70	70	70	80	80	80	80
Livello di rumorosità	dB(A)	72	72	74	76	76	76	76	79	76	76	76	76
Capacità del contenitore	Lt	45	45	100	100	100	100	100	100	100	100	100	100
Dimensioni	mm	550 X 900	550 X 900	650 X 1.100	650 X 1.100	650 X 1.100	650 X 1.100	650 X 1.100	650 X 1.100	660 X 1.200	660 X 1.200	660 X 1.200	660 X 1.200
Altezza	mm	1.120	1.120	1.400	1.400	1.400	1.400	1.400	1.400	1.510	1.510	1.510	1.510
Peso	Kg	80	80	130	140	140	155	155	190	155	155	175	175

Filtro primario

Superficie	cm²	15.000	15.000	3.800	3.800	3.800	3.800	3.800	3.800	2.400	2.400	2.400	2.400
Classe EN 60335-2-69	IFA BGIAM-PES	Classe M	Classe M	Classe M	Classe M	Classe M	Classe M	Classe M	Classe M	Classe M	Classe M	Classe M	Classe M
Materiale		Poliestere	Poliestere	Poliestere	Poliestere	Poliestere	Poliestere	Poliestere	Poliestere	Poliestere	Poliestere	Poliestere	Poliestere
Sistema di pulizia del filtro		Manuale	Manuale	Manuale	Manuale	Manuale	Manuale	Manuale	Manuale	Manuale	Manuale	Manuale	Manuale

TRIFASE ALTA POTENZA



		PUMA 10	PUMA 15 P	PUMA 15 S	PUMA 18 P	PUMA 18 S	PUMA 20	PUMA 25	PUMA 30 P	PUMA 30 S	PUMA 35 P	PUMA 35 S
Codice		A500	A540	A560	A580	A571	A557	A574	A600	A610	A619	A624
Potenza	kW-HP	7,5 - 10	11 - 15	11 - 15	12,5 - 18	12,5 - 18	15 - 20	18,5 - 25	22 - 30	20 - 28	25 - 34	25 - 34
Voltaggio / Frequenza	V/Hz	400 50/60	400 50/60	400 50/60	400 50/60	400 50/60	400 50/60	400 50/60	400 50/60	400 50/60	400 50/60	400 50/60
IP		55 F	55 F	55 F	55 F	55 F	55 F	55 F	55 F	55 F	55 F	55 F
Vuoto in continuo	mBar	260	300	440	290	530	350	320	275	460	220	445
Massima portata d'aria	m³/h	730	950	550	1120	720	950	1.380	1.770	1.100	2.100	1.130
Bocchetta di aspirazione	Ømm	100	100	100	100	100	100	100	130	130	130	130
Livello di rumorosità	dB(A)	74	74	74	74	74	74	74	78	78	78	78
Capacità del contenitore	Lt	175	175	175	175	175	175	175	175	175	175	175
Dimensioni	mm	850 X 1.550	850 X 1.550	850 X 1.550	850 X 1.550	850 X 1.550	850 X 1.550	850 X 1.550	1.050 X 1.950	1.050 X 1.950	1.050 X 1.950	1.050 X 1.950
Altezza	mm	1.980	1.980	1.980	1.980	1.980	1.980	1.980	2.300	2.300	2.300	2.300
Peso	Kg	295	330	310	355	335	350	370	560	620	654	650

Filtro primario

Superficie	cm²	45.000	45.000	45.000	45.000	45.000	45.000	45.000	110.000	110.000	110.000	110.000
Classe EN 60335-2-69	IFA BGIAM-PES	Classe M	Classe M	Classe M	Classe M	Classe M	Classe M	Classe M	Classe M	Classe M	Classe M	Classe M
Materiale		Poliestere	Poliestere	Poliestere	Poliestere	Poliestere	Poliestere	Poliestere	Poliestere	Poliestere	Poliestere	Poliestere
Sistema di pulizia del filtro		Manuale	Manuale	Manuale	Manuale	Manuale	Manuale	Manuale	Manuale	Manuale	Manuale	Manuale



Via Venezia, 32 - 10088 Volpiano (TO)
Tel. +39 011 98.59.117

www.depureco.com
depureco@depureco.com

